

SEVENOAKS SCHOOL



YEAR 7 (11+) ENTRANCE EXAMINATION

January 2021

for entry in September 2021

MATHEMATICS



Name: _____

School: _____

Time allowed: 1 hour

Equipment needed: Pen, pencil, eraser, ruler.

Information for candidates:

1. Calculators are NOT allowed.
2. Write your name and school on this sheet.
3. Write your answers on the question paper in the space provided.
4. There are 20 questions in this paper, try to answer all of them, but don't worry if you don't complete the paper. If you get stuck, just go on to the next question and if you have time at the end come back to the one(s) you left.
5. There are 60 marks in total available for this paper. Marks for each question are shown in square brackets [] after the question.
6. Show all your working. You may be awarded marks for correct working even if your final answer is incorrect, and a correct answer unsupported by correct working may not receive full marks.

1. Calculate the following, making sure to show your working.

a) $41 - 101 + 29$

Answer _____ [1]

b) $625 \div 5$

Answer _____ [1]

c) 51×11

Answer _____ [1]

2. Convert the following fractions to decimals.

a) $\frac{3}{10}$

Answer _____ [1]

b) $\frac{17}{50}$

Answer _____ [1]

c) $\frac{14}{20}$

Answer _____ [1]

3. Fill in each box with either a + or - to make the calculations true.

a) $6 \square 14 = -8$ [1]

b) $-3 \square 6 \square 11 = -8$ [1]

4. Fill in each box with a number to make the calculations true.

a) $(12 + \square) \times 5 = 100$ [1]

b) $(\square - 6) \div 5 = 9$ [1]

5. A plank of wood is 4.6 metres long.

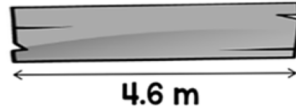

These two lengths of wood are cut from the plank.



What is the length of the wood left?

Answer _____ [2]

6. Place the following fractions in the boxes below by arranging them from smallest to largest.

$$\frac{7}{18} \quad , \quad \frac{4}{9} \quad , \quad \frac{5}{12} \quad , \quad \frac{1}{3}$$



smallest

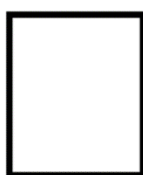

largest

[2]

7. You go into a local bakery shop and you see the following items are on sale. For each item, calculate how much it will cost.

a) A pie originally costing £2 has been reduced by 12%.

Answer _____ [2]

b) A doughnut originally costing 80p has been reduced by 20%.

Answer _____ [2]

8. A factory makes these wooden cubes.

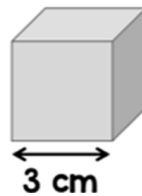

They are packed into large boxes.

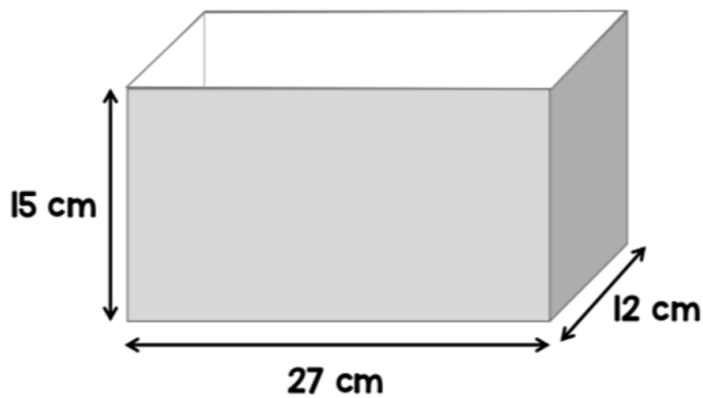

How many wooden cubes can be packed into one large box?

Answer _____ [2]

9. Evaluate the following fractions giving your answer in its **simplest form**.

a) $\frac{2}{5} \div 6$

Answer _____ [2]

b) $3\frac{1}{3} \times 5\frac{2}{5}$

Answer _____ [2]

c) $\frac{1}{4} + \frac{1}{3} - \frac{1}{2}$

Answer _____ [2]

10. The table below shows a timetable for four trains. Train B and C do not stop at all stations, as indicated by the arrows. Use the timetable to answer the following questions.

Stations	Train A	Train B	Train C	Train D
Birmingham New Street	09:40	10:05	11:05	12:35
Birmingham International	09:52	10:16	11:15	12:47
Coventry	10:08	10:30	11:28	13:00
Leamington Spa	10:25	↓	11:45	13:15
Banbury	10:42	↓	↓	13:35
Oxford	11:06	11:24	↓	13:52
Reading	11:35	11:55	12:50	14:25

a) What time does the 10:05 train from Birmingham New Street arrive in Oxford?

Answer _____ [1]

b) Which train is the fastest train from Birmingham New Street to Oxford?

Answer _____ [1]

c) You get to Birmingham International at 11:12. How long will you have to wait for a train to Banbury?

Answer _____ [1]

11. Charlotte has a map of a village. The scale on the map is such that 1cm represents 25m.

a) On the map, the church is 7cm from the village store. What is the real distance from the church to the village store?

Answer _____ [1]

b) Charlotte calculates her car is parked approximately half a kilometre from the church. On the map, how many cm would represent this distance?

Answer _____ [2]

12. Write down the next **two** numbers in each of the following sequences.

a) 0.04, 0.1, 0.16, ...

Answer _____ [2]

b) $3, 9, 27, \dots$

Answer _____ [2]

c) $0.3, \frac{1}{3}, \frac{11}{30}, \dots$

Answer _____ [2]

13. Solve for x in the following equations.

a) $6x + 3 = 21$

Answer _____ [2]

b) $15(x - 5) = 75$

Answer _____ [2]

c) $\frac{3}{4}x + 5 = 26$

Answer _____ [2]

14. a) Let p be a prime number. Circle **one** expression below which could also be a prime number.

$2p$

$7p$

$p - 4$

p^2

[1]

b) Give a reason for your answer above.

_____ [1]

15. A farmer keeps chickens in an enclosure given below. If each chicken requires $3m^2$, what is the maximum number of chickens that the farmer can keep?

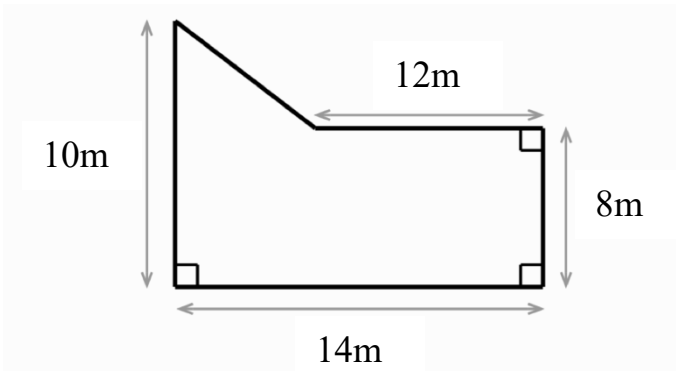

Answer _____ [3]

16. Otto knows that his car requires 27.5 litres of fuel to drive 110 miles. He wants to drive from London to Edinburgh, a distance of 405 miles. How much fuel will he need?

Answer _____ [3]

17. Given the scales below, what is the weight of one circle?

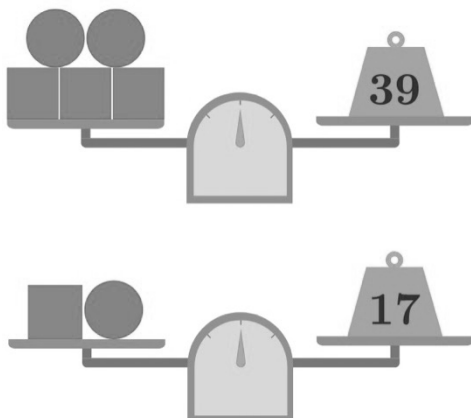

Answer _____ [2]

18. Harry is five years younger than Ron. In four years' time, Ron will be twice as old as Harry. Find Ron's present age. **Make sure you show your working.**

Answer _____ [2]

19. The two large right-angled triangles are identical. All internal triangles are similar in shape to the larger triangles.

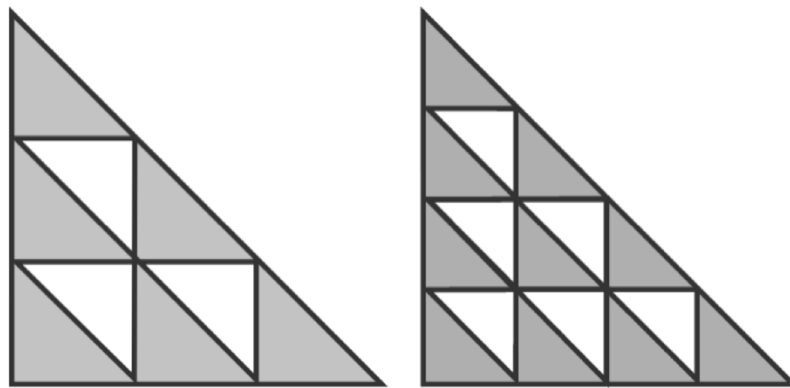

Which is larger, the shaded area in the triangle on the left or the shaded area in the triangle on the right? **You must give a reason for your answer.**

20. The board shown has 32 cells, one of which is labelled S and another F. The shortest path starting at S and finishing at F involves exactly nine other cells and ten moves, where each move goes from cell to cell 'horizontally' or 'vertically' across an edge.

How many paths of this length are there from S to F?

You must show your working.

